

Introduction

The document describes a high efficiency LED driver designed to drive an LED driver at a current of 320 mA from an input voltage range of 5 VDC to 32 VDC, output support 2~16 series 1W LED.

The XL6005 also provides a sophisticated range of protection features including output LED open faults and soft-start function. Accurate hysteretic thermal shutdown ensures safe average PCB temperatures under all conditions. Design with very low parts count.

This document contains the converter specification, schematic, PCB diagram, conducted EMI measurements, bill of materials and typical performance characteristics.

Schematic

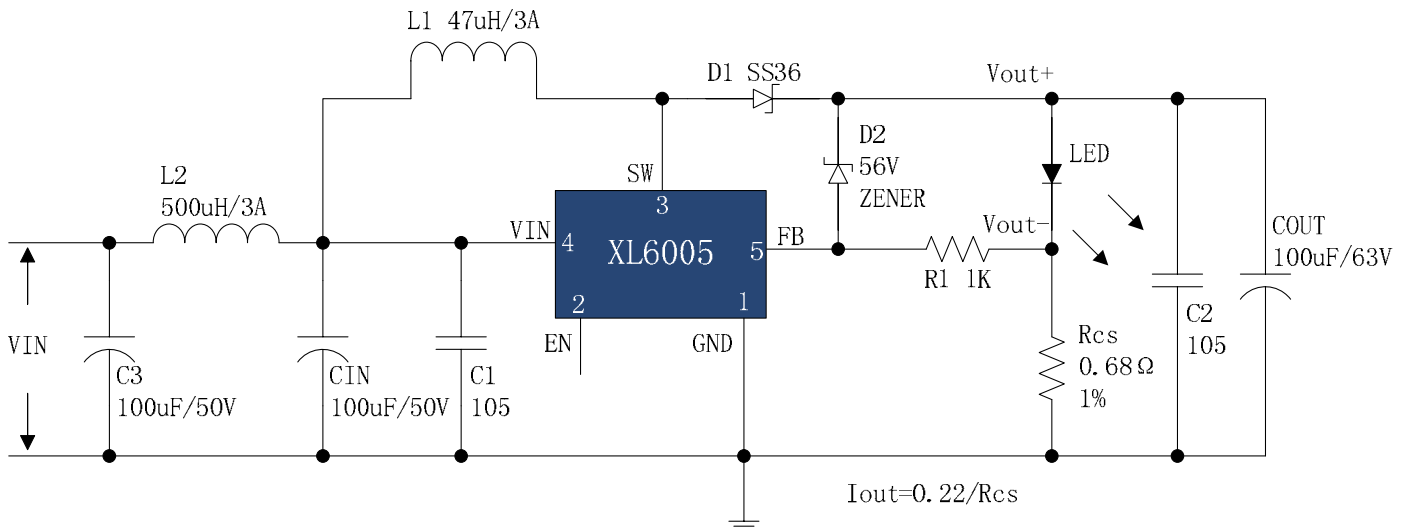

XL6005 VIN=DC5V~DC32V, IOU=320mA Typical Application Circuit

Pin Description

Pin Number	Pin Name	Description
1	GND	Ground Pin.
2	EN	Enable Pin. Drive EN pin low to turn off the device, drive it high to turn it on. Floating is default high.
3	SW	Power Switch Output Pin (SW).
4	VIN	Supply Voltage Input Pin. XL6005 operates from a 5V to 32V DC voltage.
5	FB	Feedback Pin (FB). The feedback threshold voltage is 0.22V.

Bill of Materials

Item	Qty	Ref Des	Description	Mfg Part Number	Mfg
1	2	C1,C2	1uF,50V,Ceramic,X7R,0805	C2012X7R1H105K	TDK
2	1	C3	100uF,50V, Electrolytic,(8x11.5)	YXA-50V-100uF	Rubycon
3	1	Cin	100uF,50V, Electrolytic,(8x11.5)	YXA-50V-100uF	Rubycon
4	1	Cout	100uF,63V, Electrolytic,(8x11.5)	YXA-63V-100uF	Rubycon
5	1	D1	60V,3A,Schottky Barrier Rectifier,SMC	SS36	Fairchild
6	1	D2	56V,0.5W,Zener,MINI MELF	ZMM55C56	ICM
7	1	L1	47uH,3A,Toroidal,10*4		
8	1	L2	500uH,3A,Toroidal,10*4		
9	1	R1	1K ,1%,1/10W,Thick Film,0805	RL0805xR-071001L	Yageo
10	1	RCS	0.68 ,1%,1/4 W,Thick Film,1206	RL1206xR-07R680L	Yageo
11	1	U1	Xlsemi ,XL6005 ,T0252-5L	XL6005	XLSEMI

Performance Data

Efficiency VS Load current

Efficiency VS LED String

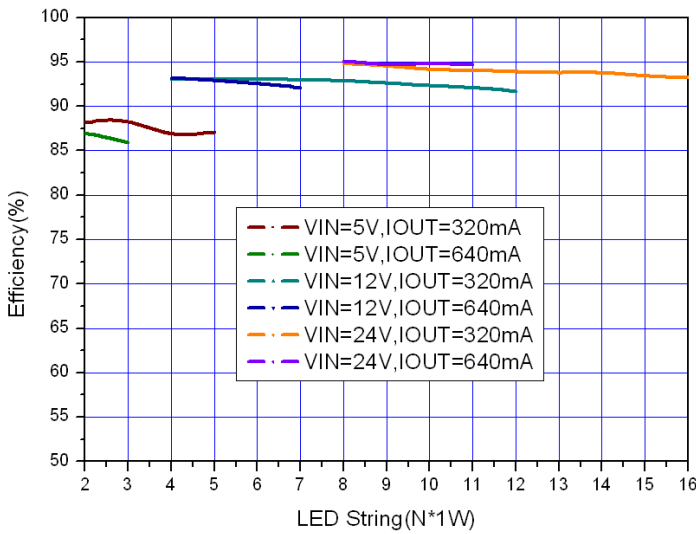

Line and Load Regulation

Output current VS Input voltage

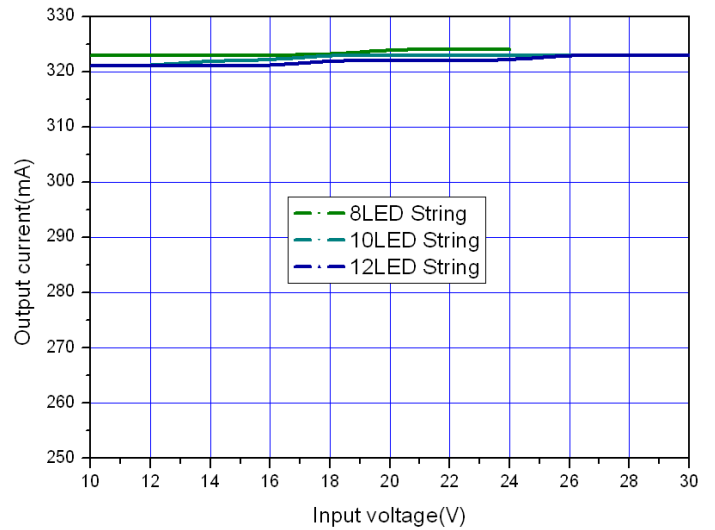

Conducted EMI Test Results

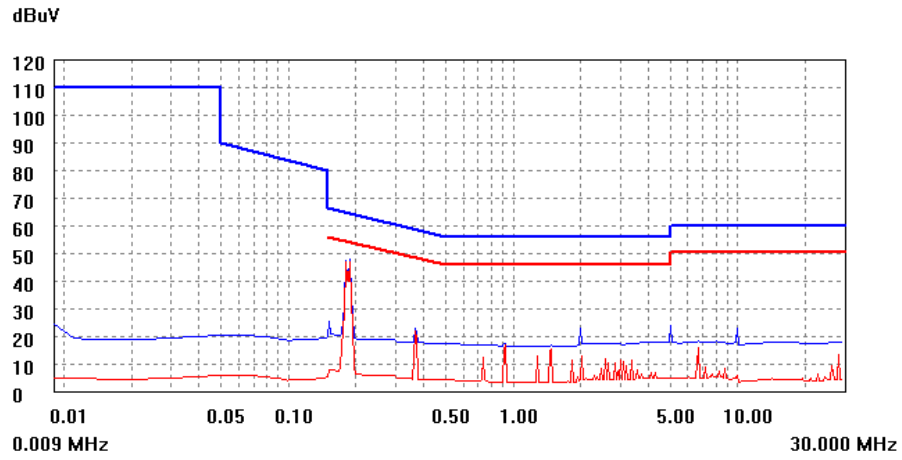

Conducted EMI, Vin=12VDC, Vout=33V, Iout=320mA, EN55015 Limits.

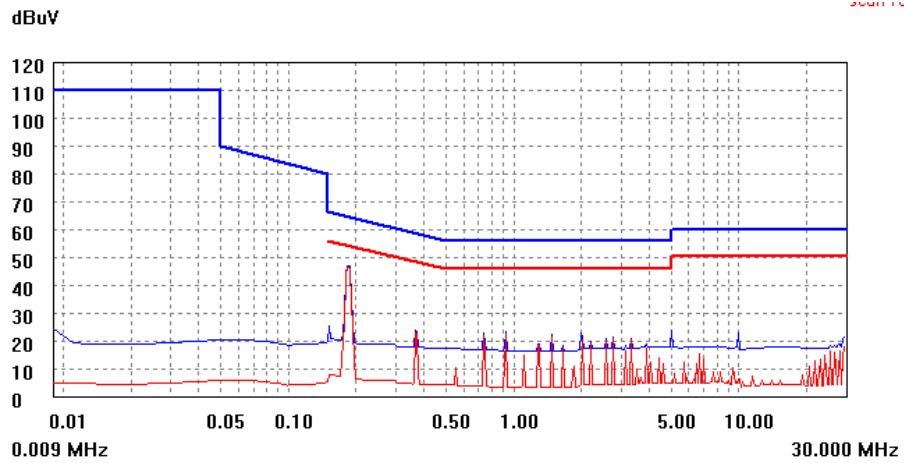

Conducted EMI, Vin=24VDC, Vout=33V, Iout=640mA, EN55015 Limits.

Populated Circuit Board Phtograph

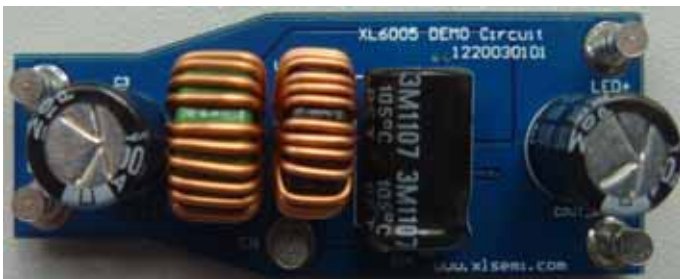

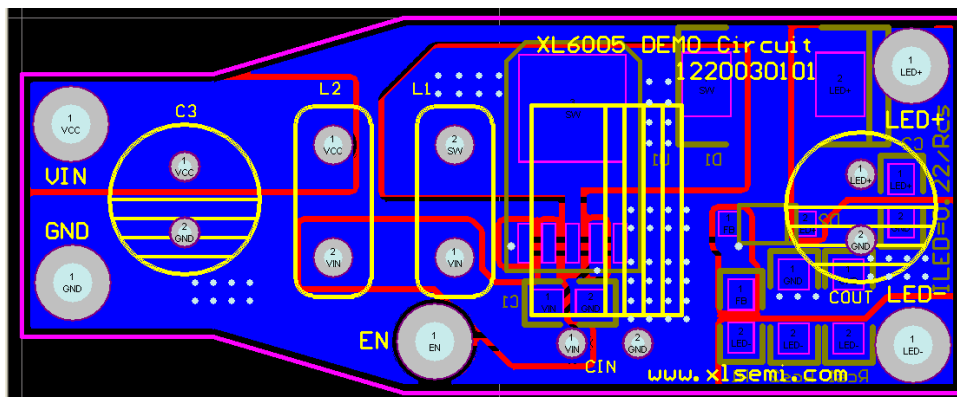
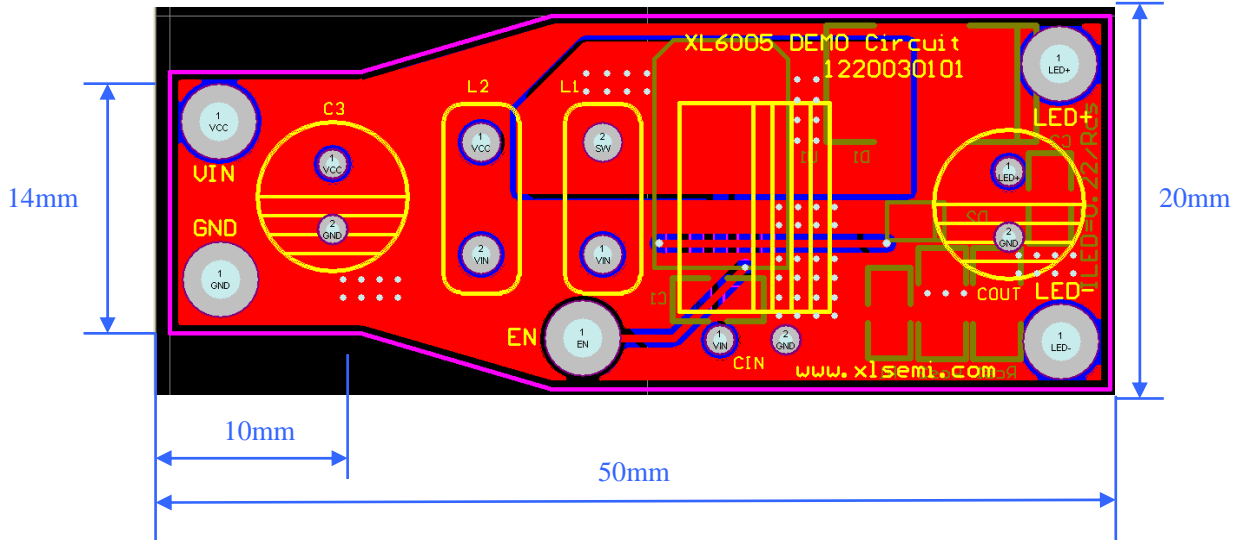
PCBLayout**Note :**

1. Keep feedback wiring away from inductor and schottky.
2. VIN, SW, LED+, LED- lines must be short and ground plane construction for best results.